

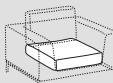

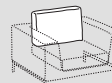

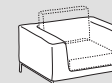



Blazer Poltrona



	 Seduta - Seat	 Schienale - Backrest	 Struttura - Structure	Mix - Mix
Rivestimento <i>Upholstering</i> (10)	Sfoderabile <i>Removable</i> -	 Fabric	-	-
	Non sfoderabile <i>Not removable</i>  Fabric	-	 Fabric	 / 
Imbottiture <i>Padding</i> (7-8-9)	 D.30kg/m³ Tecnoform	 Tecnoform	 D.21kg/m³ Tecnoform	-

INFORMAZIONI TECNICHE

Struttura: (1-2-3-4-5)

Masselli portanti in legno di abete. Elementi strutturali in pannelli di legno multistrati in classe E1 e pannelli curvati di multistrati, tamponamenti in faesite.

Molleggio: (5-6)

Schienale in pannello di faesite.

Seduta in nastri elastici di fibra propilenica e lattice incrociati e meccanicamente pretensionati.

Note:

Poltrona versione mix cuscino schienale sfoderabile, tutto il resto non sfoderabile.

TECHNICAL INFORMATION

Structure: (1-2-3-4-5)

Spruce wood load-bearing screeds. Structural elements made of class E1 plywood and curved plywood panels, faesite infills.

Springing: (5-6)

The back is made of hardboard panels.

Seat with pre-tensioned crossed propylene fibre and latex elastic webbing.

Note:

Armchair mix version back cushion removable cover, everything else not removable.

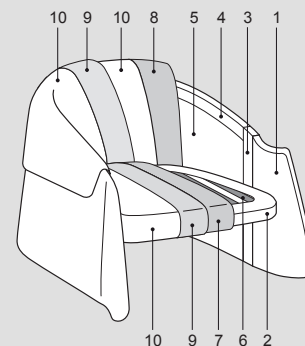
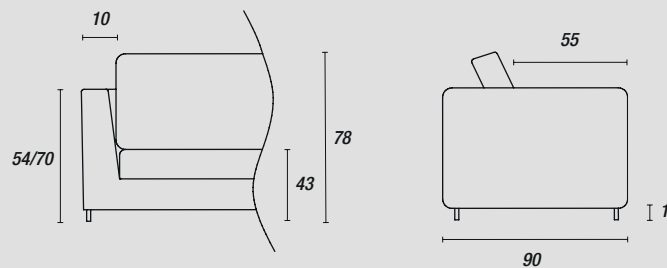

Piedini - Feet :

