

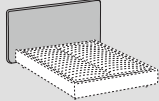

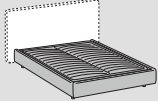





Avalon

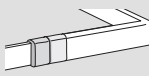

	 Testiera - Headboard	 Giroletto - Bed frame		
Rivestimento Upholstering (10)	Sfoderabile Removable  	Sfoderabile Removable  		
	Non sfoderabile Not removable -	Non sfoderabile Not removable -		
Imbottiture Padding (6-7-8-9)	 +  D.21-30-40kg/m ³	 +  D.30kg/m ³		

INFORMAZIONI TECNICHE

Struttura: (1-2-3-4-5)

Testiera in pannelli di legno multistrato in classe E1, legno di abete e pannelli di faesite; longoni e pediera in pannelli di legno multistrato in classe E1, legno di abete e pannelli di faesite.

Note:

Inserti nella testiera e nel giroletto in tessuto Tallin o Malaga.
Possibilità di regolare l'altezza della rete su cui appoggia il materasso.

Caratteristiche relative ai materiali utilizzati descritte nella sezione tecnica a fine listino.
Set biancheria da letto e coprirete disponibili nella sezione accessori per letti.

TECHNICAL INFORMATION

Structure: (1-2-3-4-5)

Headboard made of class E1 multilayer wood, fir wood and faesite panels; side rails and footboard made of class E1 multilayer wood, fir wood and faesite panels.

Note:

Headboard and bed-ring inserts in Tallin or Malaga fabric.
Height-adjustment option for the bedbase that supports the mattress, allowing total or partial integration.

For characteristics of the used materials, see the technical section.
Bed linen and bed-base cover set available in the section "Bed accessories"

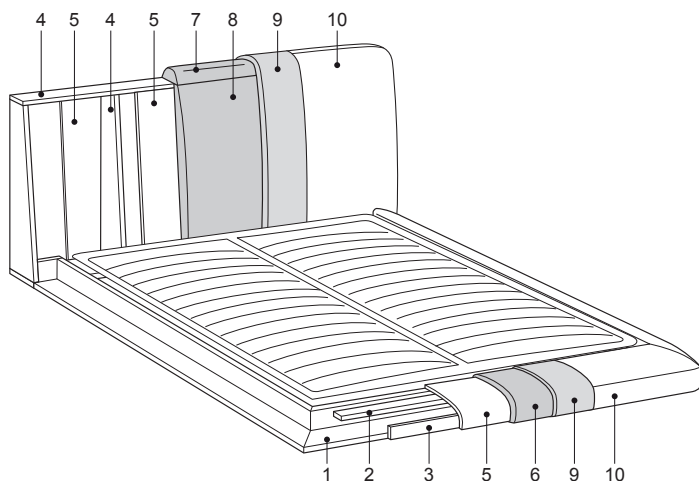

Versioni disponibili (per dimensioni selezionate)
Available versions (by selected dimensions)

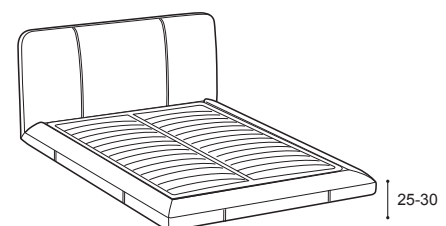







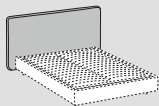
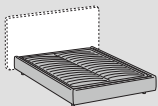

Disponibile per materasso da:
Available for mattress:



Avalon mix

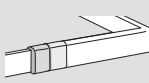

	 Testiera - Headboard	 Giroletto - Bed frame		
Rivestimento Upholstering (10)	Sfoderabile Removable  / 	Sfoderabile Removable  / 		
	Non sfoderabile Not removable -	Non sfoderabile Not removable -		
Imbottiture Padding (6-7-8-9)	 +  D.21-30-40kg/m ³	 +  D.30kg/m ³		

INFORMAZIONI TECNICHE

Struttura: (1-2-3-4-5)

Testiera in pannelli di legno multistrato in classe E1, legno di abete e pannelli di faesite; longoni e pediera in pannelli di legno multistrato in classe E1, legno di abete e pannelli di faesite.

Note:

Inserti nella testiera in tessuto Tallin e Malaga, fascia perimetrale in pelle Polar. Possibilità di regolare l'altezza della rete su cui appoggia il materasso.

Caratteristiche relative ai materiali utilizzati descritte nella sezione tecnica a fine listino. Set biancheria da letto e coprirete disponibili nella sezione accessori per letti.

TECHNICAL INFORMATION

Structure: (1-2-3-4-5)

Headboard made of class E1 multilayer wood, fir wood and faesite panels; side rails and footboard made of class E1 multilayer wood, fir wood and faesite panels.

Note:

Headboard inserts in Tallin and Malaga fabric, perimeter band in leather Polar. Height-adjustment option for the bedbase that supports the mattress, allowing total or partial integration.

For characteristics of the used materials, see the technical section. Bed linen and bed-base cover set available in the section "Bed accessories"

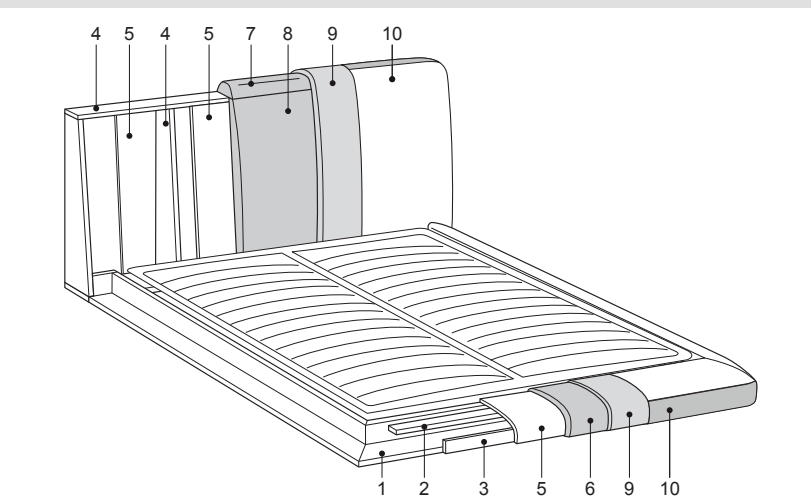

Versioni disponibili (per dimensioni selezionate)
 Available versions (by selected dimensions)

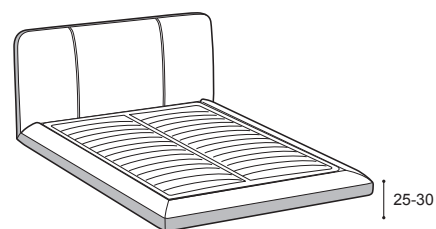

Disponibile per materasso da:
 Available for mattress:

